

ZAZA PLI

BY 

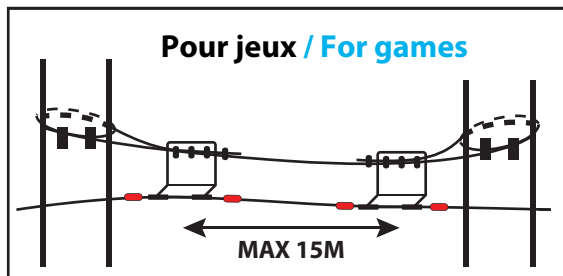

AVANTAGES / ADVANTAGES:

- Platine étudiée pour les enfants
- Plate designed for children
- Adaptable sur parcours existants sans modification sur câble $\varnothing 12$ ou 10
- Adaptable on existing ropes courses without modification on cable $\varnothing 12$ or 10

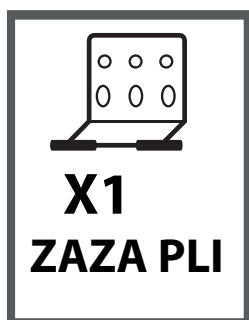
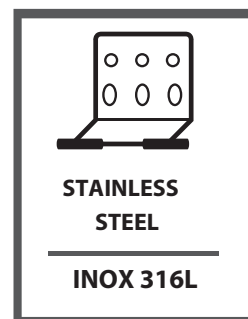
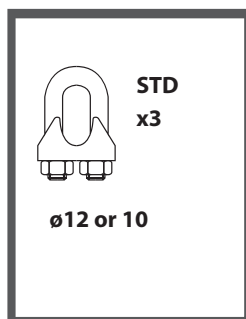
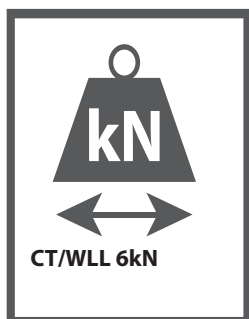

=

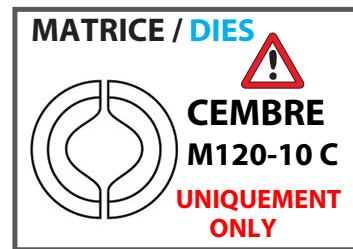
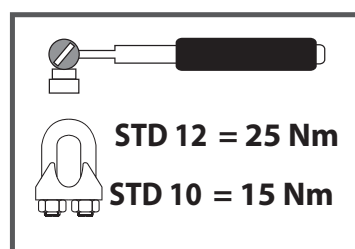
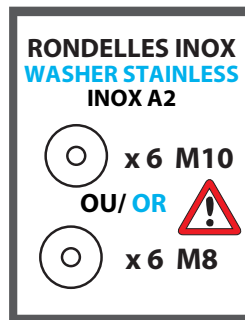
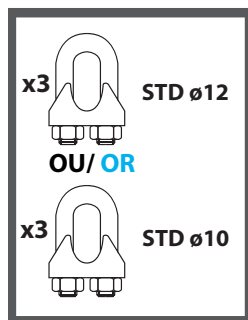

Operation 1

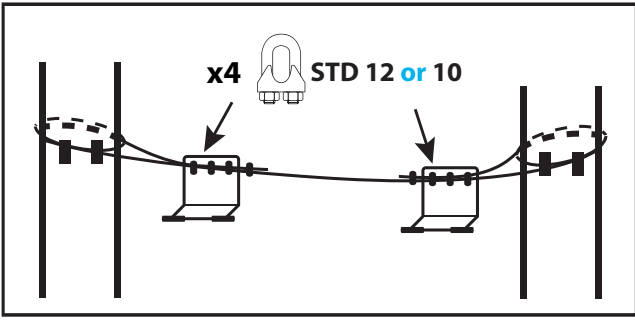

NORMES DE MONTAGE STANDARDS OF ASSEMBLY



EN 15567-1
EN 13411-1/7
STANDARDS - ACCT



Operation 2

Exemples (non contractuel) de systèmes de fixations NOT Contractual examples system of fixing

Fixation sur les câbles de main du jeu
Fixing on the hand's cable of the game

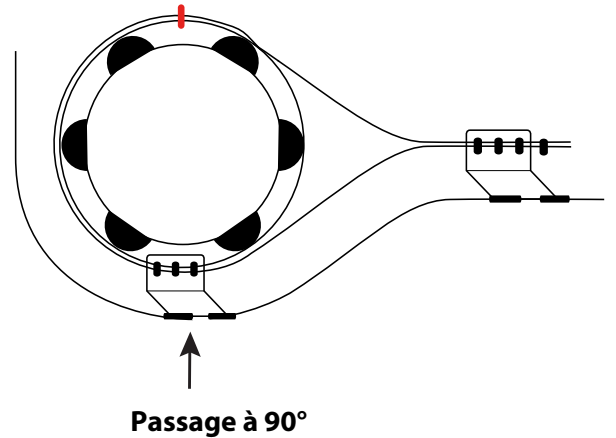
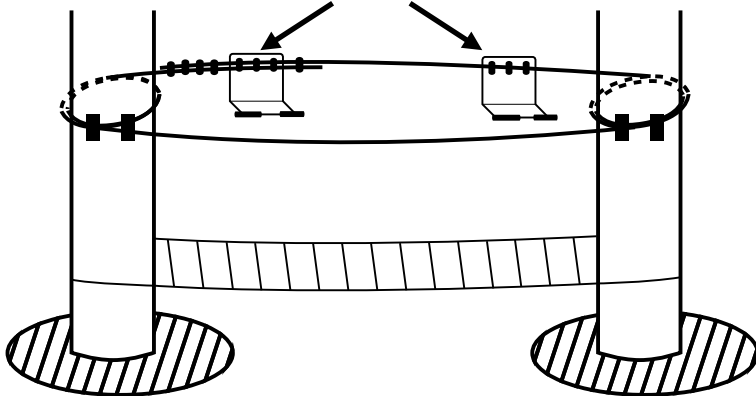

2 BRINS TIRANTS
Both fastening Wire

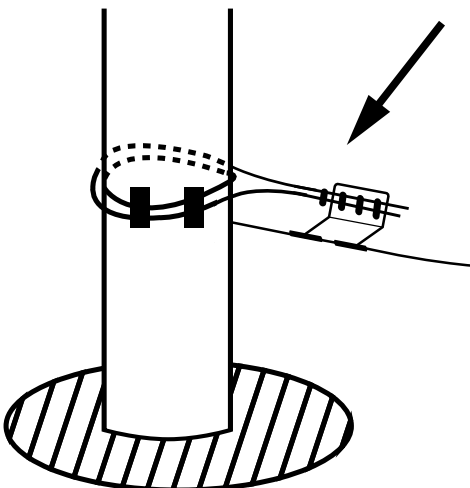

Boucle de retour avec brin mort
Feedback loop with dead end rope

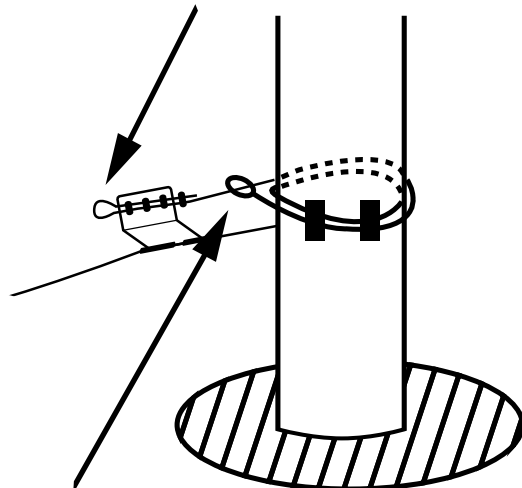

Montage possible : droite / gauche
Possible assembly: right / left

Jeux Roulant / Rolling Games

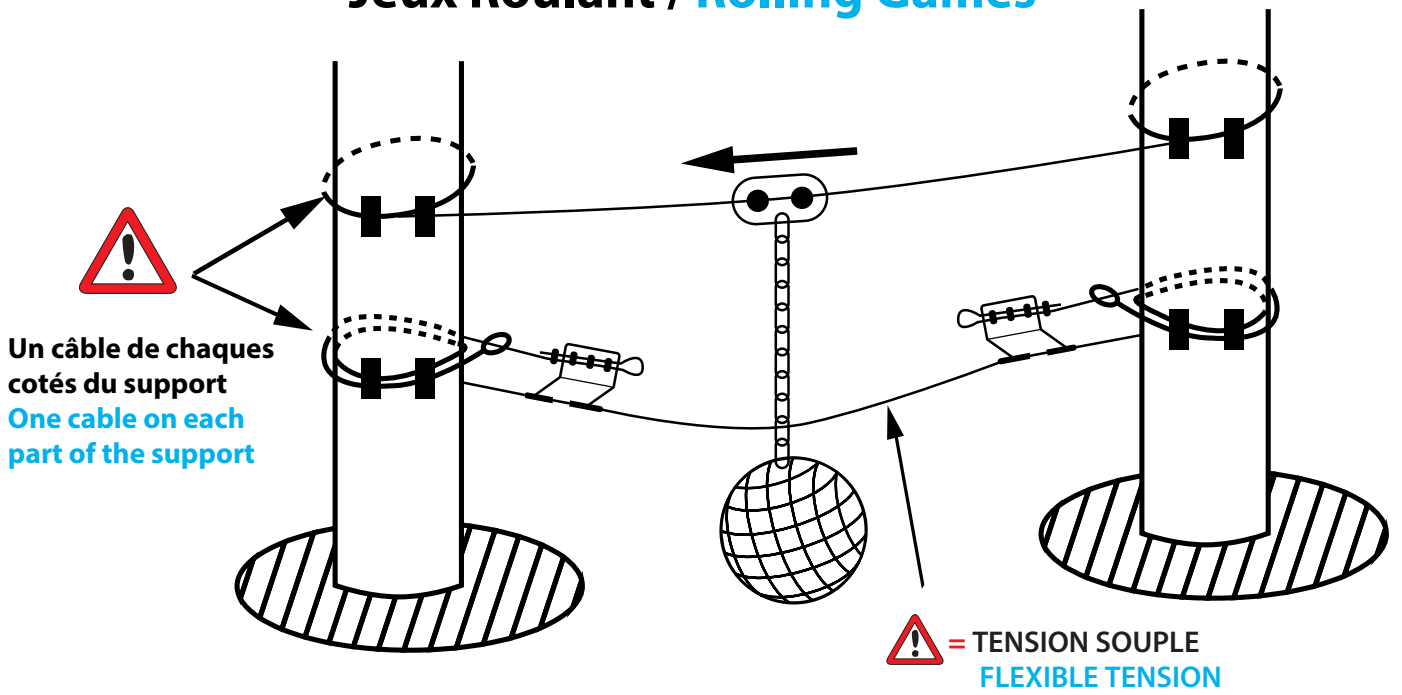

Operation 3

RECOMMANDATION DE MONTAGE RECOMMENDATION of ASSEMBLY

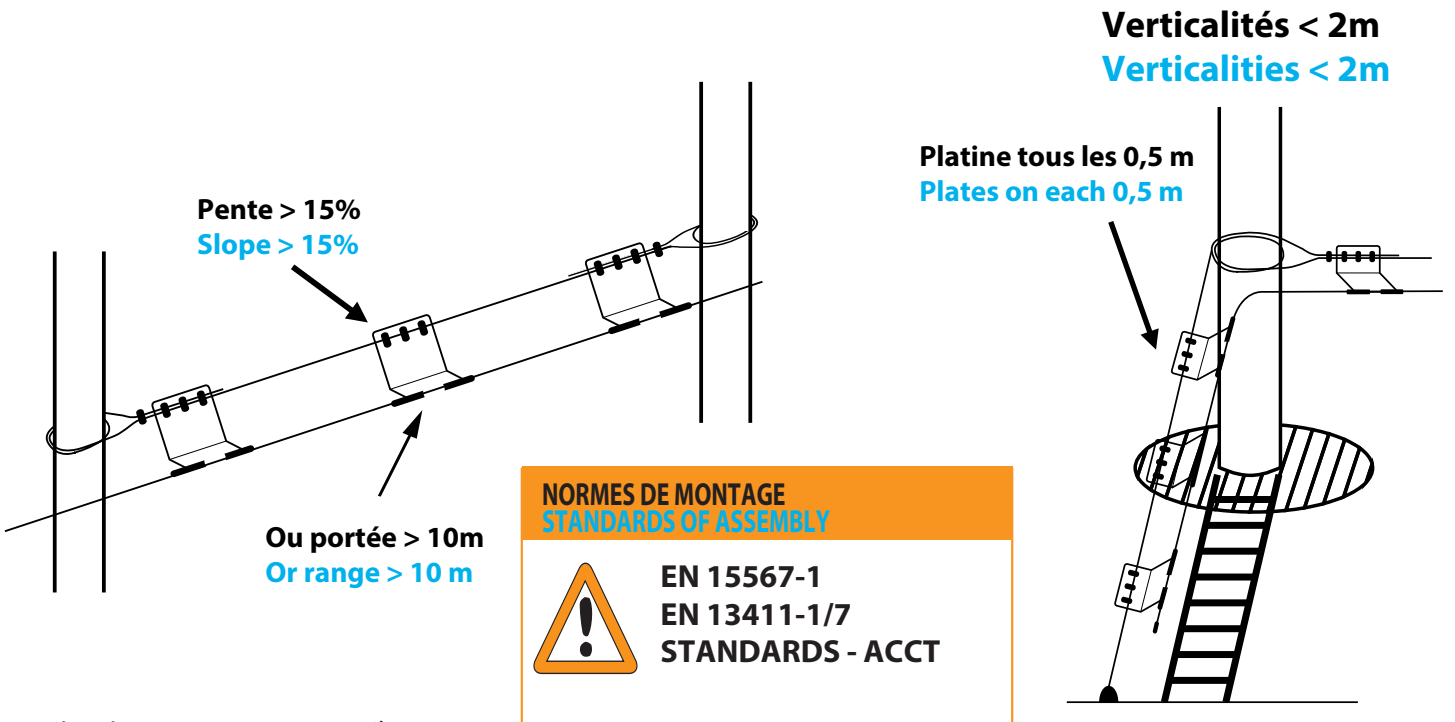

Fixation sur poteau = 2 x Ø10mm
Fixing on a pole = 2 x Ø10mm

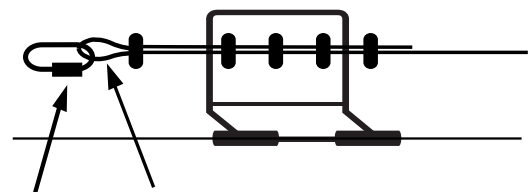
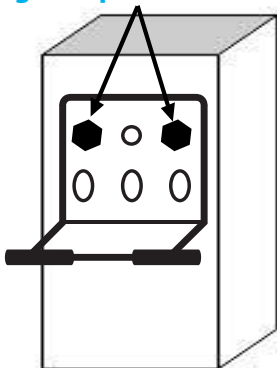

Maillon rapideGo Ø10
Quick link Lo Ø10

Cosse-coeur
Thimble with eye

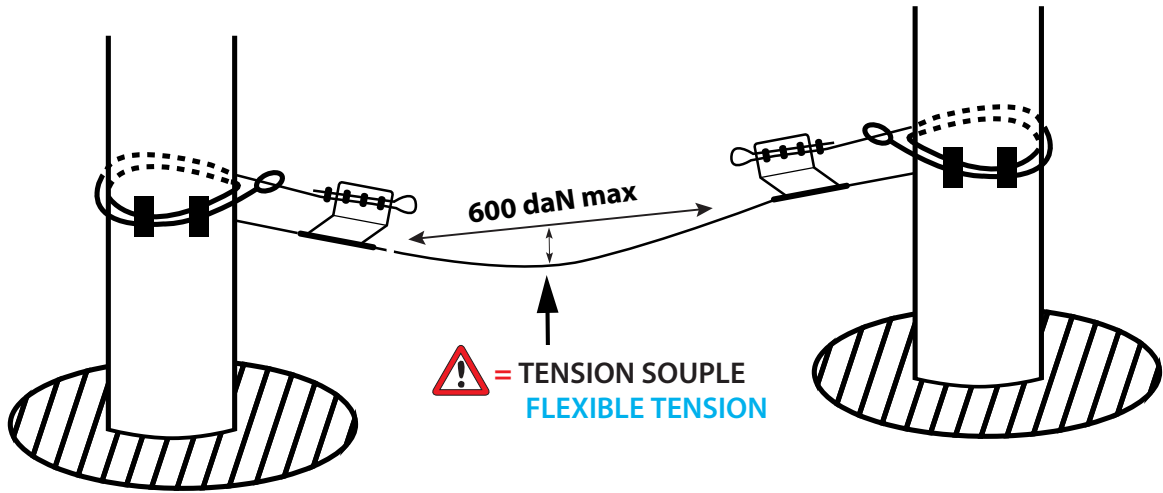

Sens de montage des platines = Sens de circulation du crochet
Mounting direction of the Plate = Running direction of the hook

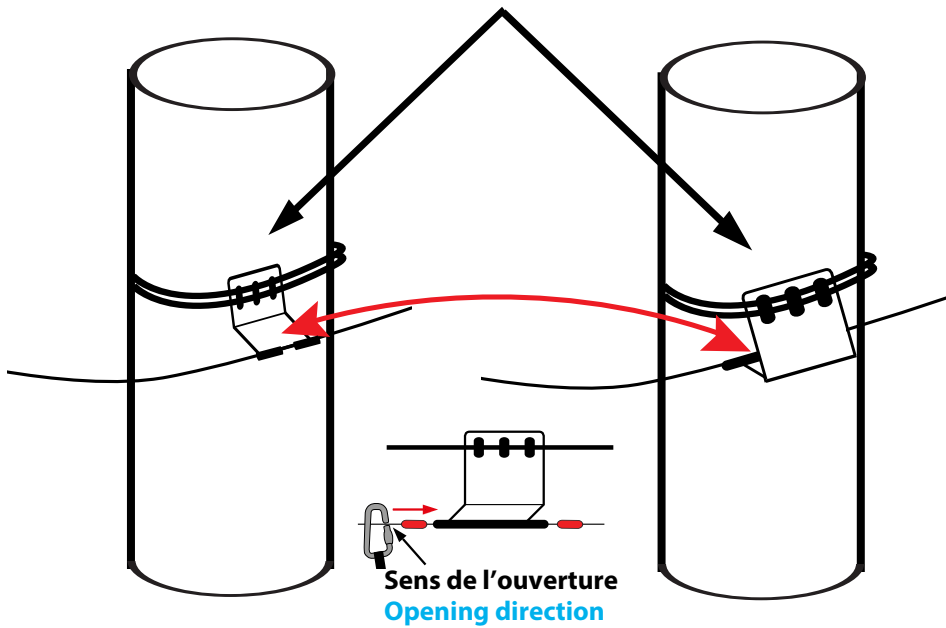

Operation 4

Montage Câble ligne de Vie Continue Assembly of the Cable for the Life Line

A = Lubrification tube platine / Lubrication tube of plate

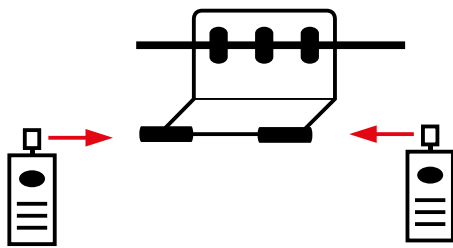

Lubrifiant sans silicone / Lubricant without silicone

B = Enfiler le câble / Put on the Cable

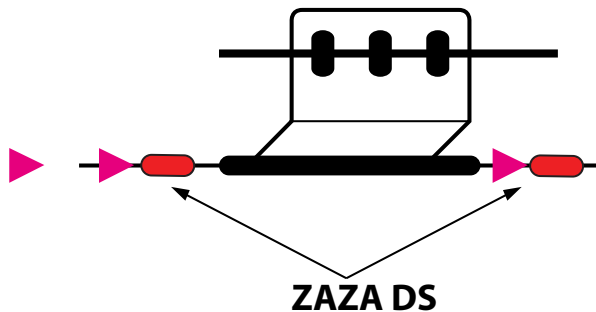

=1 ZAZA DS de chaque côté
=1 ZAZA DS on each side

C = Vérifier le sens de montage des Platinas

Check the correct assembly direction of the plates

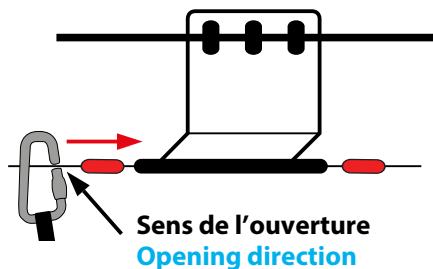

Sens de montage des platines = Sens de circulation du crochet
Mounting direction of the Plate = Running direction of the hook

D = Ordre de sertissage des douilles : ZAZA DS

Crimping order ferrules : ZAZA DS

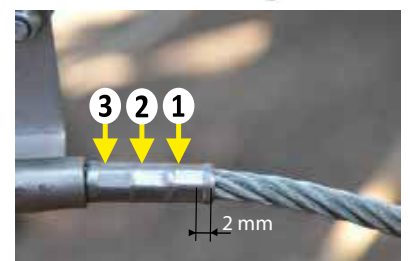
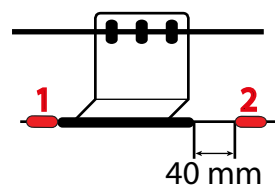
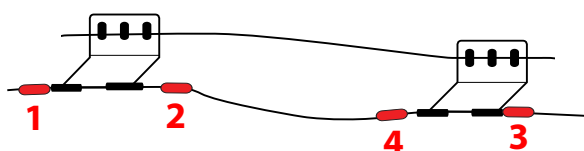

E = Platines intermédiaires / Intermediaries plates:

Verticalités < 2m
Verticalities < 2m

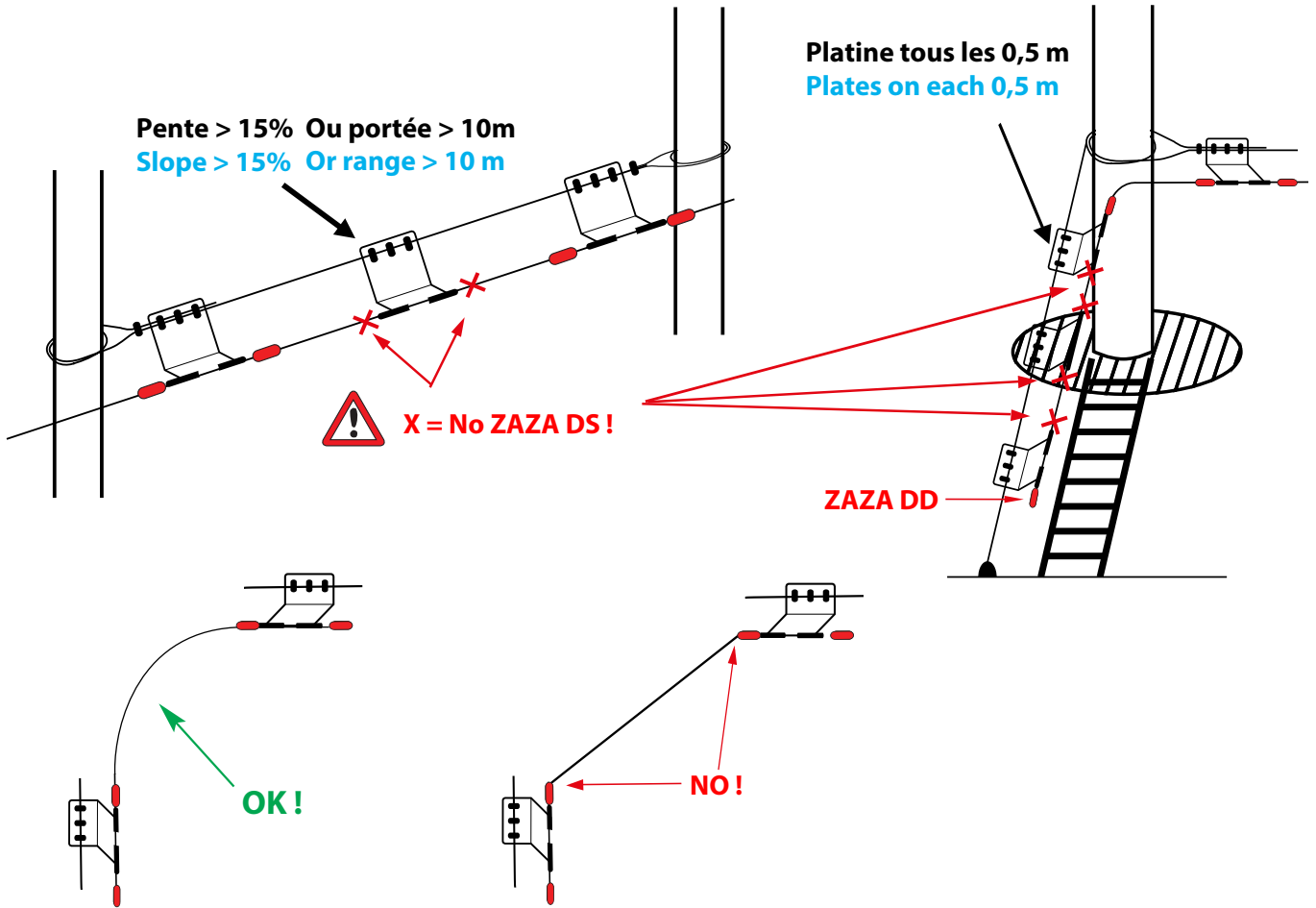

F = Sertissage Platines Départ / Arrivée Crimping Departure / Arrival Plates

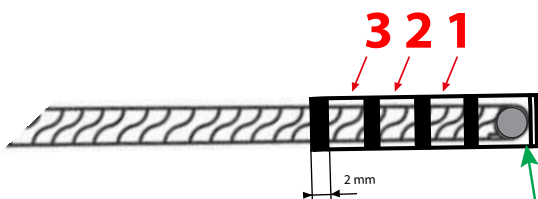
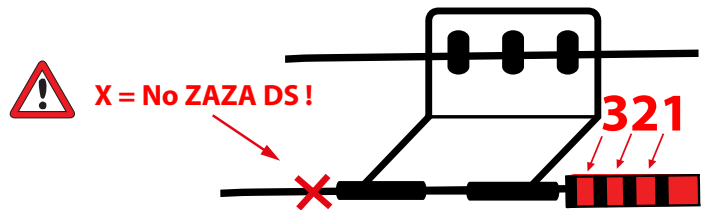
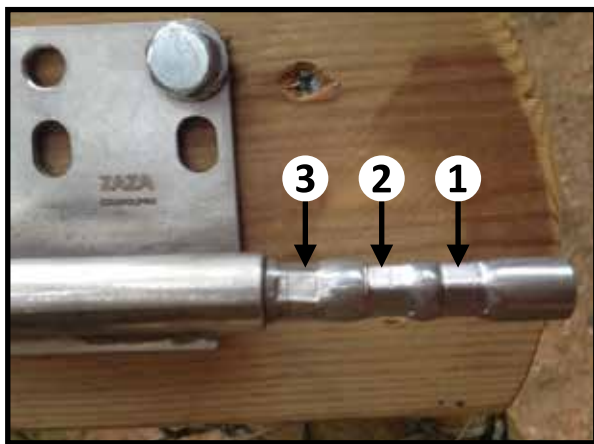

Câble en butée
Cable in abutment

OK!

Operation 5

Douille de Raccord : ZAZA DR Connecting Sleeve : ZAZA DR

- Pour raccorder 2 sections de câble / To connect 2 part of cable
- Pour réparation ou changement de jeux / To repair or change of games

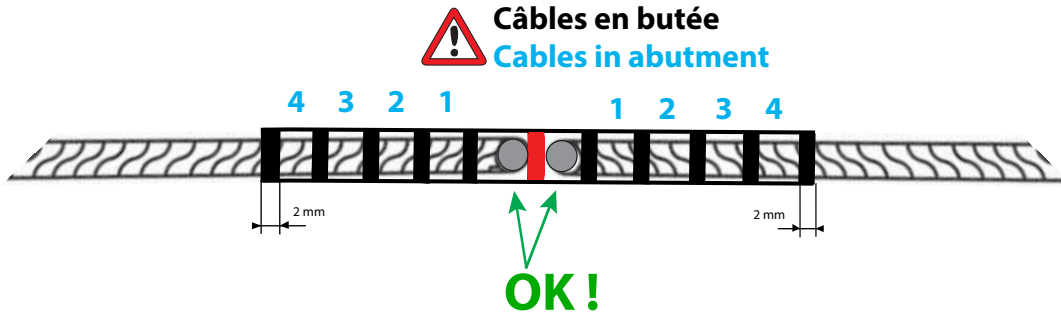

Ordre de sertissage



La douille ZAZA DR doit être entre deux platines de départ et d'arrivée de jeux

The ZAZA DR ferrule have to be between two plates of departure and arrival of a game

